

# Loop-Powered Digital Indicators

**Knick** >

The 830 X loop-powered digital indicators are uni-versally applicable. The range (either 0 to 20 mA or 4 to 20 mA) is simply selected via terminals.

Display starts working at an operating current of only 0.3 mA.

The low voltage drop of 0.5 V allows application in current loops with low load voltage.

## 830 X Loop-Powered Process Indicator

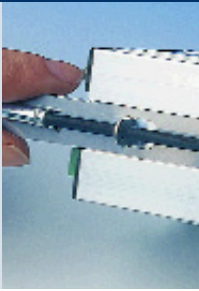

### Bargraph for quick range overview

The digital indicators provide a bargraph in addition to the digital display. This gives you all information on your process variable at a single glance.

### Versatile setting capabilities

Zero, span, and min/max outputs can be adjusted as desired, enabling direct readout of measured values such as temperature, power, displacement, pH value etc. The indicator comes with a symbol set for standard engineering units. The symbols can easily be replaced. Thanks to microprocessor technology, you do not require a high-precision external reference current for parameter setting. Even during operation, the settings can be changed without problems.

### Loop-powered. Your advantage.

The digital indicators are simply inserted into the current loop like passive analog indicators. Since power supplies and their wiring are not required, costs could decisively be reduced, allowing for displays which have been too expensive before. Applications in hazardous locations become easier and less expensive since the costs for intrinsically safe power supplies and wirings can be saved.



# 830 X Process Indicator

Isolation Amplifiers  
Transmitters

Indicators

Process Analytics

Portable Meters

Laboratory Meters

Sensors

Fittings

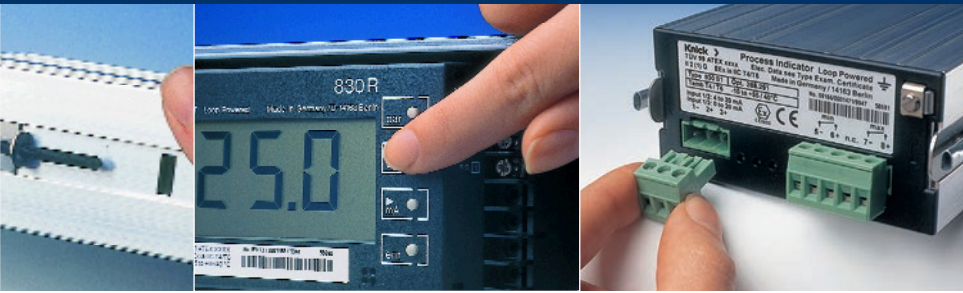

**Knick** >



In addition, the reliability has considerably been improved since a power failure in the control room does not interrupt the data flow. And, in contrast to conventional digital indicators, there is no coupling between measuring loop and power supply.

## Construction

The product line includes indicators in modular cases as well as large and small cases for installation in equipment and control panels. The cases are sealed to IP 65.

## Floating min/max outputs on request

The two optionally available min/max outputs with IS/IS separation can be set as normally closed or normally open contacts. Limit values, hysteresis and switch-on delay can be set as desired.

## EMV to NAMUR\*

EMC design ensures reliable measurements even under unfavorable ambient conditions.

## HART communication

The indicators transmit HART signals disturbance-free. Measured value display is not affected.

\* German committee for measurement and control standards in the chemical industry

## The facts

Digital indication without power supplies and supply leads

No signal interference due to power supply coupling

Power failure without effect on indication

No parasitic voltages

Unproblematic, extremely low-cost application in hazardous area

Universal range selection

Exchangeable unit symbols

Adjustable, floating min/max outputs, optional

Signal isolation between IS circuits

IP 65

Large 23 mm characters,  
– 4-digit display  
– Span up to 10,000 counts  
– Display range –9999 to +9999

Range overview by integrated bargraph

Voltage drop 0.5 V

Settings user defined without external reference current

Change of settings also during operation

Settings protected by passcode

For hazardous-area applications

For use in HART circuits

Warranty  
**3 years!**

### Warranty

Defects occurring within 3 years from delivery date shall be remedied free of charge at our works (carriage and insurance paid by sender).



# Loop-Powered Digital Indicators

## 830 X Process Indicator

### ■ Product Line

| Instrument                    |  | Ref. No.        |
|-------------------------------|--|-----------------|
| 830 X R<br>Process Indicator  | Loop-powered $\oplus$ indicator in modular case with standard symbol set                   | <b>830 X R</b>  |
| 830 X S1<br>Process Indicator | Loop-powered $\oplus$ indicator in panel-mount case (96 x 48 mm) with standard symbol set  | <b>830 X S1</b> |
| 830 X S2<br>Process Indicator | Loop-powered $\oplus$ indicator in panel-mount case (144 x 72 mm) with standard symbol set | <b>830 X S2</b> |
| <b>Options</b>                |  |                 |
| Additional Pg cable gland     | For version R as branching box   | <b>119</b>      |
| Outputs                       | Versions S1 and S2 with two min/max outputs (60 V DC, 150 mA, 0.7 / 0.35 V)                | <b>291</b>      |
| Range selection               | Range fixed according to customer requirements   | <b>365</b>      |
| <b>Accessories</b>            |  |                 |
| Symbol                        | Other unit symbol (not standard symbol set)  | <b>ZU 0129</b>  |
| Pipe mount kit                | Pipe-mount kit (only version R)  | <b>ZU 0154</b>  |

### ■ Standard symbol set

|    |     |                         |                       |                        |
|----|-----|-------------------------|-----------------------|------------------------|
| °C | pH  | $\mu\text{S}/\text{cm}$ | $\text{mS}/\text{cm}$ | mm                     |
| %  | ppm | 1/min                   | kg                    | t                      |
| mA | A   | mbar                    | bar                   | kPa                    |
| mV | V   | $\text{m}^3$            | $\text{m}^3/\text{h}$ | $\text{Nm}^3/\text{h}$ |
|    |     |                         |                       |                        |

# 830 X Process Indicator

Isolation Amplifiers  
Transmitters

Indicators

Process Analytics

Portable Meters

Laboratory Meters

Sensors

Fittings

**Knick** 

## ■ Specifications

|   |  |
|---|--|
| Input<br>II 2(1) G EEx ia IIC T4/T6           | 4 to 20 mA, voltage drop approx. 0.5 V<br>0.3 to 20 mA, voltage drop approx. 3.2 V   |
| Display                                       | LCD: character height 23 mm (R, S2), 16 mm (S1)<br>4-digit measured value display, sign, 3 decimal points<br>Function indicators: par, 0 mA, 4 mA, 20 mA, min, max, hyst, s, n/c, n/o, adj, bargraph<br>limits<br>Bargraph with 2 % resolution, height approx. 3.5 mm (R, S2), approx. 2.5 mm (S1)   |
| Display range                                 | -9,999 to +9,999   |
| Range selection                               | Span up to 10,000 counts, displacement up to ±9,999 counts<br>Bargraph user defined within span<br>Rising / falling characteristic   |
| Keypad  | 4 buttons [TAB]par, [▲] span, [▶] mA, ent<br>par: [TAB]Activate parameter mode<br>[▲] span: [TAB]In parameter mode: select submenu, count up selected digit, In measuring mode: alternately display start/end of scale<br>[▶] mA: [TAB]In parameter mode: select digit, In measuring mode: display loop current<br>ent: [TAB]Confirm entered value   |
| Decimal point                                 | User defined, without, P1, P2, P3  |
| Measuring rate                                | 1/ s   |
| Accuracy                                      | <0.1 % of measured value ±2 counts   |
| Temperature coefficient                       | <0.01 % of span / K ±0.1 count / K<br>(average over permissible temperature range)   |
| Overload capacity                             | ±150 mA  |
| Min/Max outputs<br>II 2(1) G EEx ia IIC T4/T6 | Floating solid-state switches (min and max), 60 V DC, 350 mA<br>Voltage drop when switched approx. 0.5 V,<br>With input currents <0.3 mA (<3.8 mA) or >approx. 24 mA<br>the solid-state switches block<br>Hysteresis: [TAB]0 to 9,999 counts, user defined<br>Switch-on delay: [TAB]0 to 9,999 s, user defined<br>Contact type: [TAB]normally closed (n/c) or normally open (n/o), user definable<br>Separate indication of switching state on display<br>Display flashing can be turned off |
| Symbols                                       | Set of 20 symbols and five blank labels included   |
| Explosion protection                          | II 2(I)G EEx ia IIC T4/T6  |
| Terminals                                     | Stranded wire: [TAB]up to 1.5 mm <sup>2</sup><br>Single wire: [TAB]up to 2.5 mm <sup>2</sup> (S1, S2), up to 1.5 mm <sup>2</sup> (R)   |
| Data retention                                | Parameters and calibration data >10 years (EEPROM)   |
| Product family standard                       | EN 61326   |
| EMC   | Accuracy during disturbance <1 % span  |

# Loop-Powered Digital Indicators

## 830 X Process Indicator

continued – **Specifications** 830 X Process Indicator

|   | <b>830 X R</b>   | <b>830 X S1</b>   | <b>830 X S2</b>  |
|---|--|---|--|
| Ambient temperature Operation:                            | -25 to +40 °C (T6)<br>-25 to +55 °C (T5)<br>-25 to +65 °C (T4)                       | -10 to +40 °C (T6)<br>-20 to +55 °C (T4, T5)  |  |
| Storage:  | -30 to +70 °C  | -20 to +70 °C   |  |
| Adjustments   | Internal   | Front panel   |  |
| Min/max outputs   | No   | Yes (Option 291)  |  |
| Enclosure   | Version R: modular   | Version S1: panel   | Version S2: panel  |
| Material  | Al Si 12, DIN 1725, with glass pane, Insert made of Byblend, Rating plate: polyester | Front panel overlay: polyester, with window, Front: PA + GF, sides: Al, Rear: PA + GF | Front panel overlay: polyester, with glass pane, Front and sides: PA + GF, Rear: PA + GF |
| Color   | Lid: iron gray RAL 7011, Bottom: gray RAL 7001, Insert: black                        | Front: iron gray RAL 7011, Sides: Al, Rear: black, Buttons: black                     | Front: iron gray RAL 7011, Sides and rear: black, Buttons: black                         |
| Dimensions in mm (incl. terminals and cable glands)       | W 200 x H 80 x D 57  | W 96 x H 48 x D 118   | W 144 x H 72 x D 57  |
| Protection (EN 60529)<br>Front to control panel:<br>Rear: | IP 65  | IP 65<br>IP 20  |  |
| Weight  | Approx. 750 g  | Approx. 300 g   | Approx. 300 g  |

# 830 X Process Indicator



## ■ Typical applications

### Application with 2-wire transmitter and repeater power supply (e.g. Knick WG 20 or WG 21)

Indicators can be mounted either in hazardous or safe area and due to different enclosure versions on the site or in the control panel.

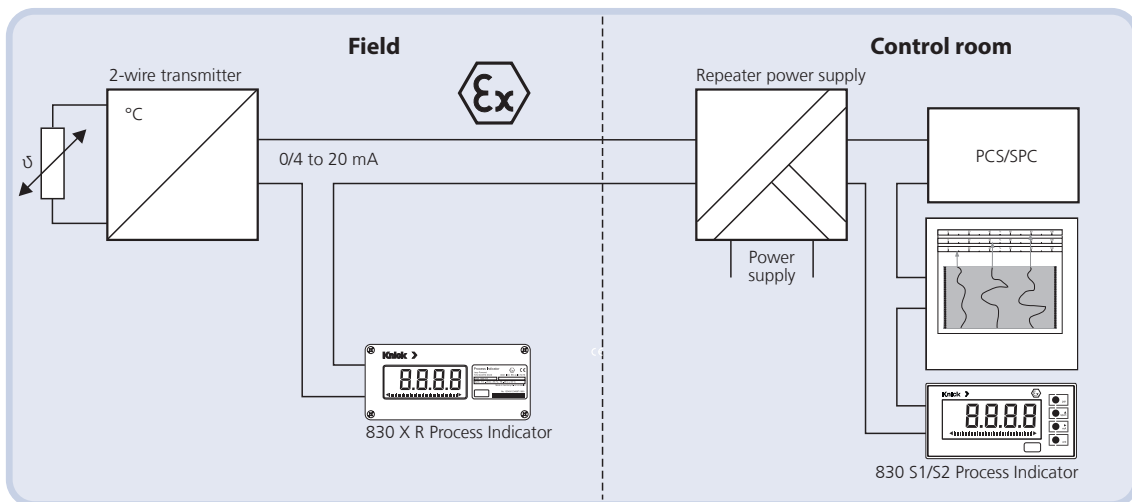

### Application with 4-wire transmitter and IS/non-IS isolator (e. g. Knick IsoTrans® 36 A7)

Indicators can be mounted either in hazardous or safe area and due to different enclosure versions on the site or in the control panel.

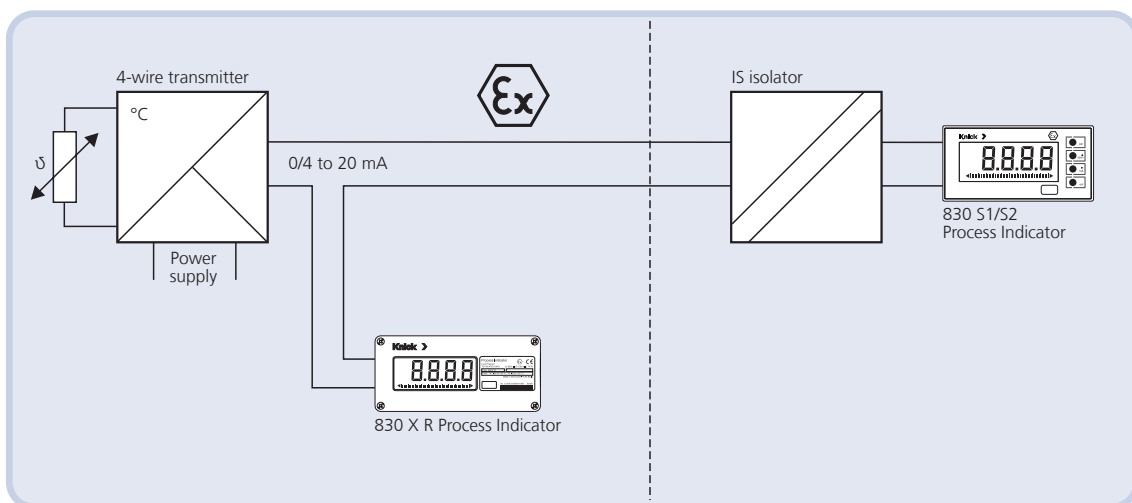

# Loop-Powered Digital Indicators

## 830 X Process Indicator

### ■ Dimension drawings

#### 830 X R Process Indicator

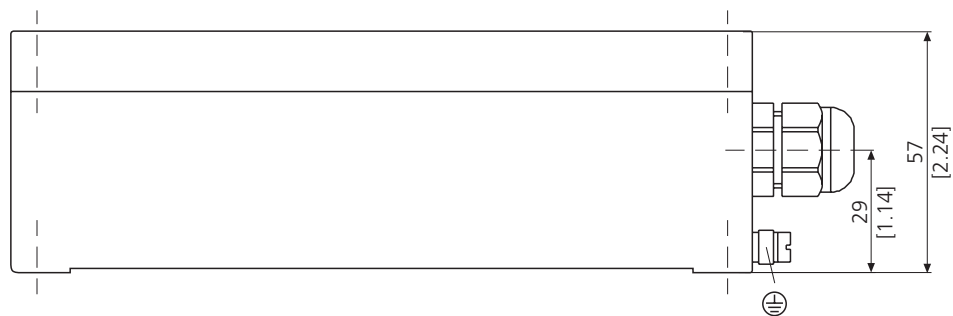

Bottom view

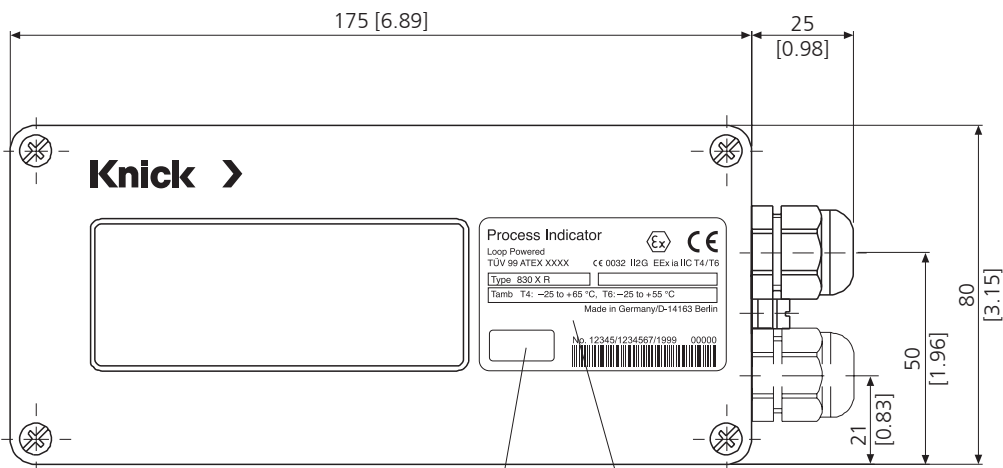

Front view with cover

Unit symbol

Rating plate

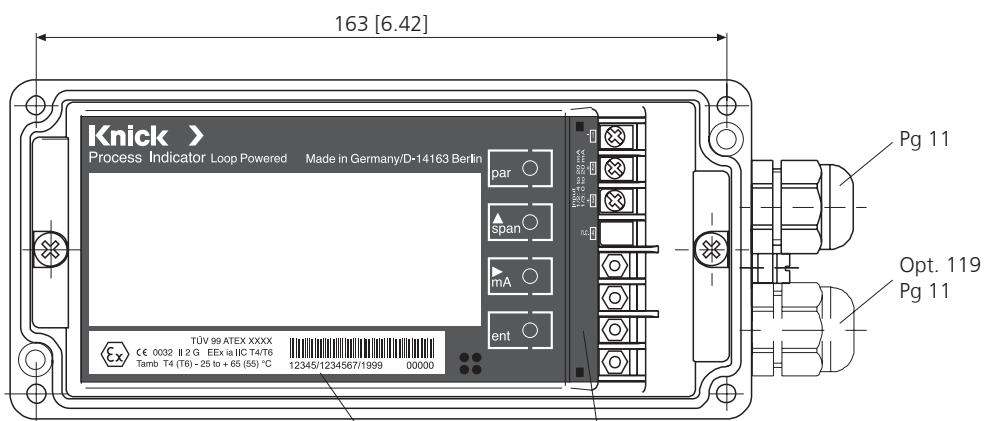

Front view without cover

Rating plate

Terminal assignments

Pg 11

Opt. 119  
Pg 11

Note: All dimensions in mm [in]

# 830 X Process Indicator

Isolation Amplifiers  
Transmitters

Indicators

Process Analytics

Portable Meters

Laboratory Meters

Sensors

Fittings



## ■ Dimension drawings

### 830 X R Process Indicator

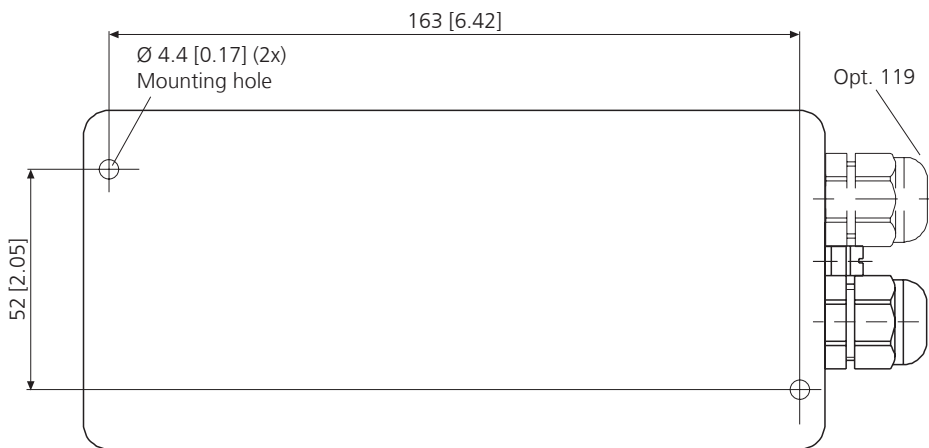

Rear view

Note: All dimensions in mm [in]



Keypad



# Loop-Powered Digital Indicators

## 830 X Process Indicator

### ■ Dimension drawings

#### ZU 0154 Pipe mount kit for 830 X R Process Indicator

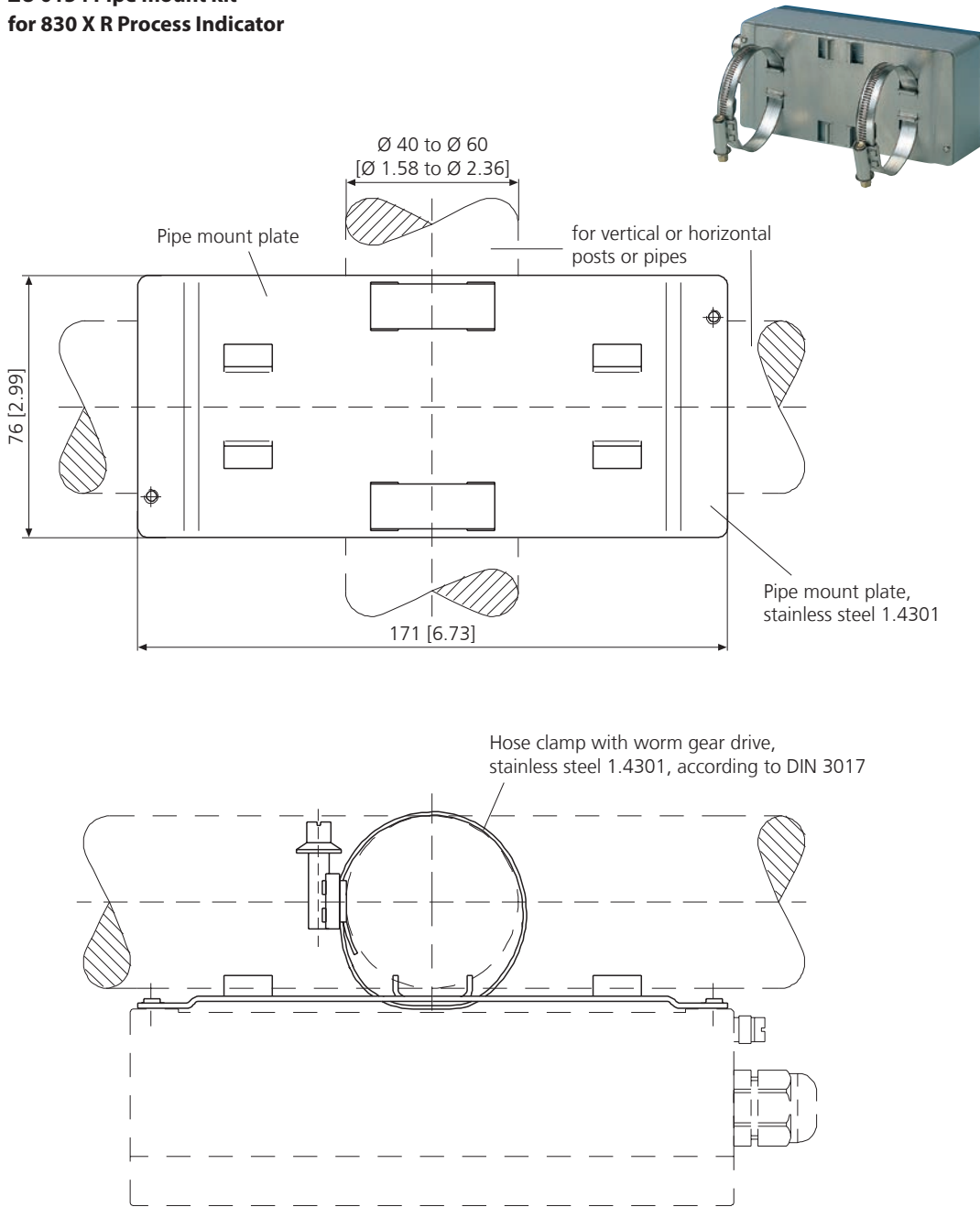

# 830 X Process Indicator



## ■ Dimension drawings

### 830 X S1 Process Indicator

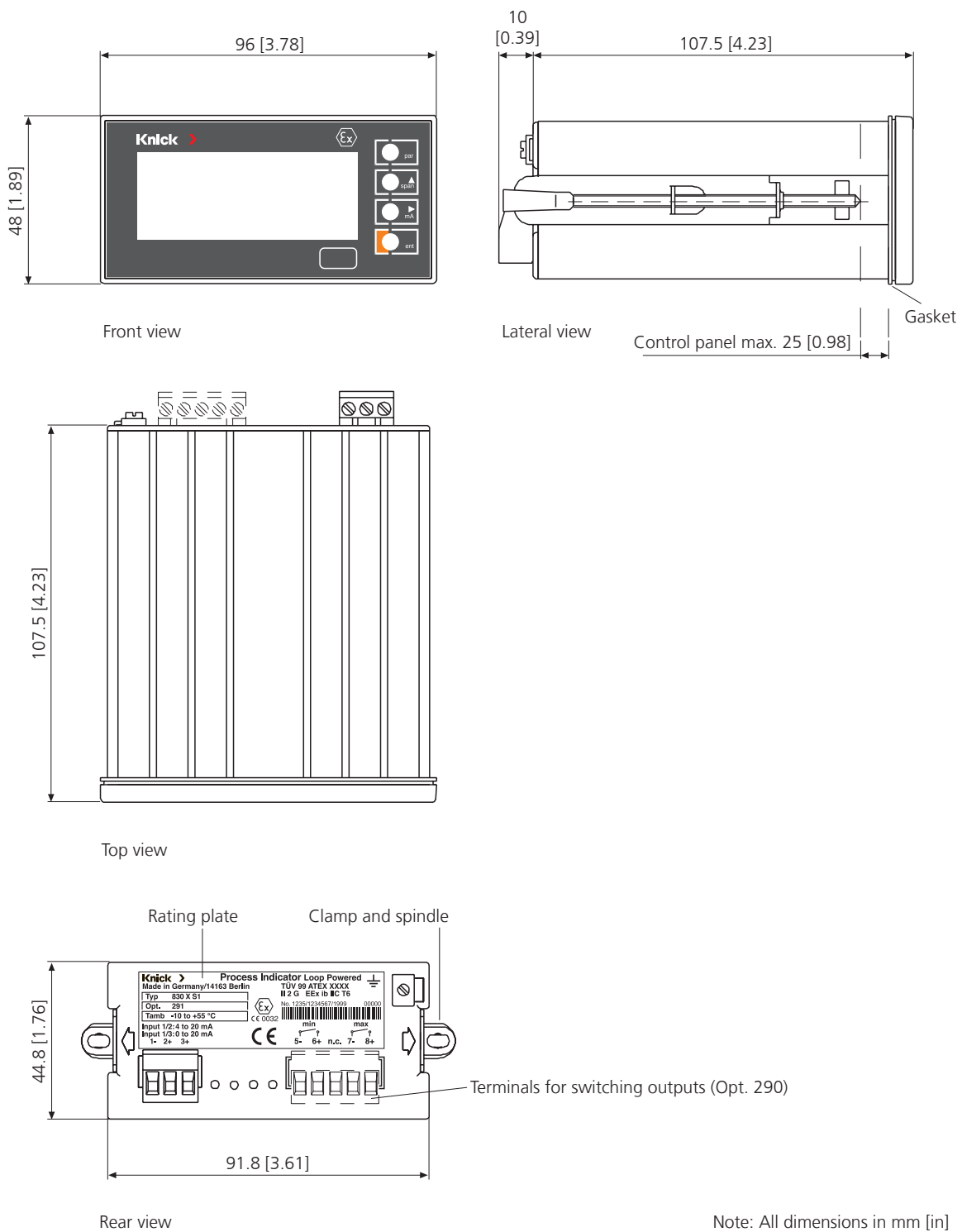

Note: All dimensions in mm [in]

# Loop-Powered Digital Indicators

## 830 X Process Indicator

### ■ Dimension drawings

#### 830 X S2 Process Indicator

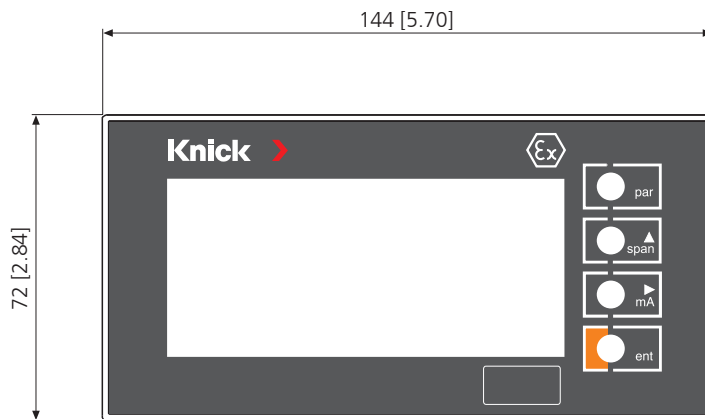

Front view

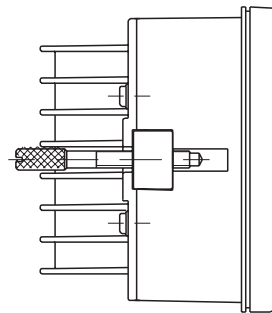

Lateral view

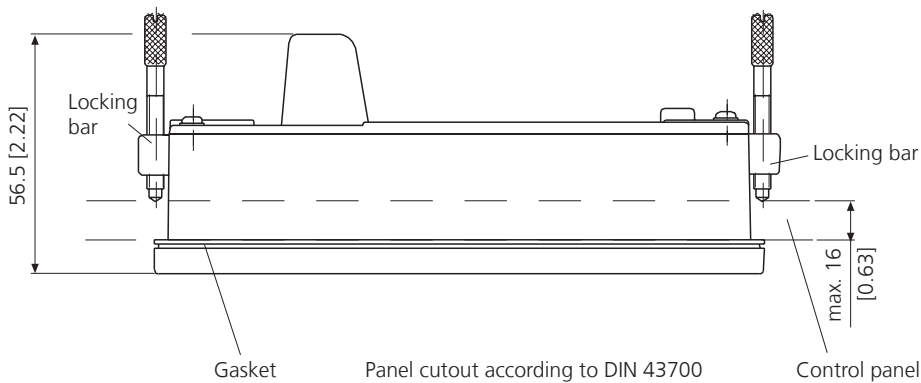

Top view

Panel cutout according to DIN 43700  
 $138^{+1} \times 68^{+0.7}$   
 $[5.43^{+0.04} \times 2.68^{+0.03}]$

Control panel

Note: All dimensions in mm [in]

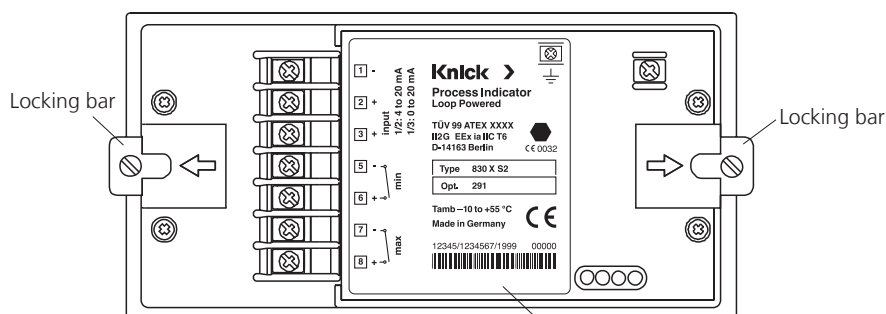

Rear view

Rating plate

# 830 X Process Indicator

Isolation Amplifiers  
Transmitters

Indicators

Process Analytics

Portable Meters

Laboratory Meters

Sensors

Fittings

